

UNLESS OTHERWISE SPECIFIED: DIMENSIONS ARE IN MILLIMETERS SURFACE FINISH: TOLERANCES: LINEAR: ANGULAR:				FINISH:		DEBUR AND BREAK SHARP EDGES		DO NOT SCALE DRAWING		REVISION	
								TRM 86 Moss Road, Southport, Lancashire PR8 4JQ			
								TITLE: <b>OVERALL DIMENSION</b>			
DRAWN:		NAME		SIGNATURE		DATE		DWG NO.		Overall	
CHK'D:										A3	
APPVD:											
MFG:											
Q.A:											
								SCALE:1:2		SHEET 1 OF 1	
								WEIGHT:			

IF IN DOUBT ASK!

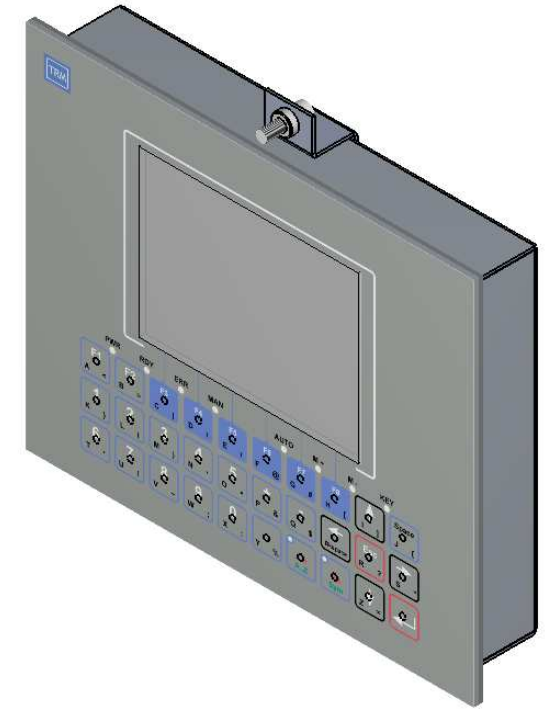
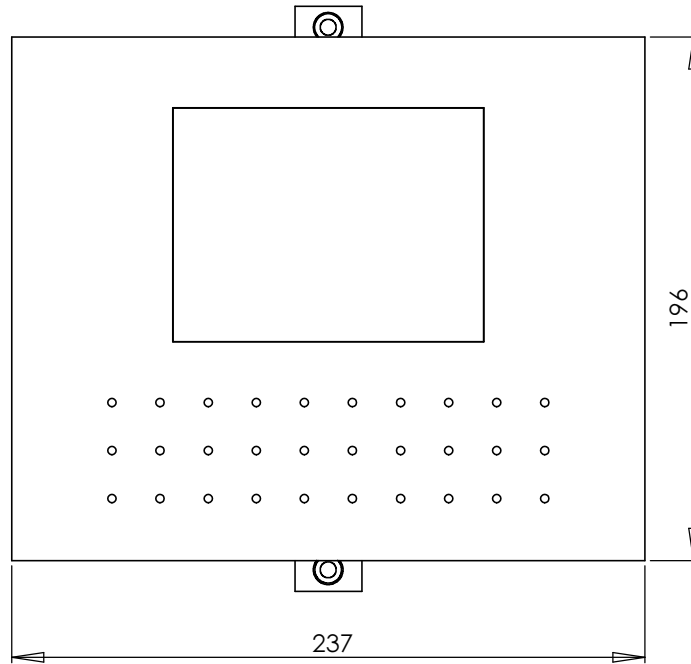
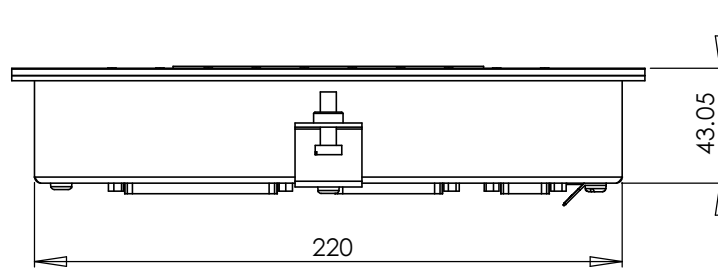
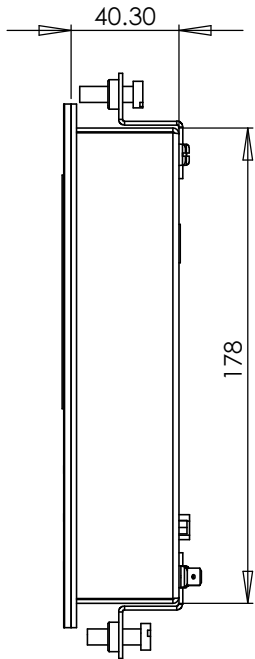

UNLESS OTHERWISE SPECIFIED: DIMENSIONS ARE IN MILLIMETERS SURFACE FINISH: TOLERANCES: LINEAR: ANGULAR:				FINISH:		DEBUR AND BREAK SHARP EDGES		DO NOT SCALE DRAWING		REVISION	
DRAWN: K MAWDSLEY				SIGNATURE:		DATE: 18/03/09		TRM +44 (0) 1704 563777		86 Moss Road Southport PR8 4JQ	
CHK'D:								TITLE: 5.7" Display with 30 Key Keypad			
APP'VD:											
MFG:											
Q.A:								MATERIAL:		DWG NO. Controller_Case_Dimensions	
								SCALE:1:2		SHEET 1 OF 1	
										A3	

IF IN DOUBT ASK!

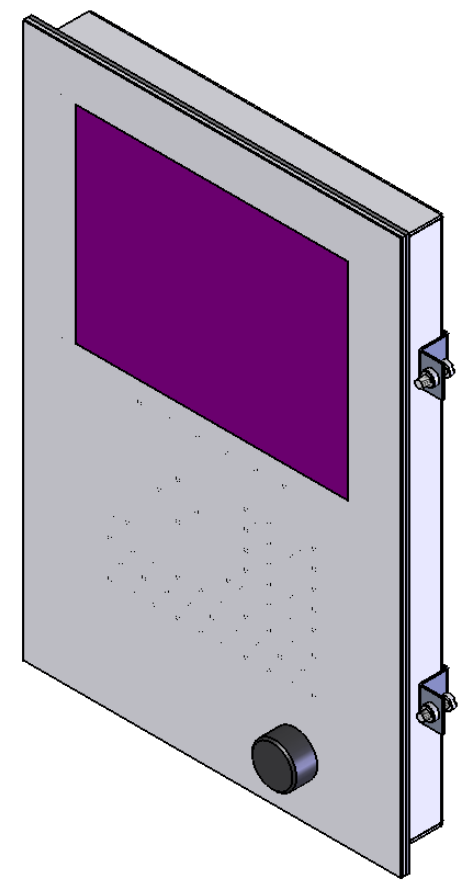
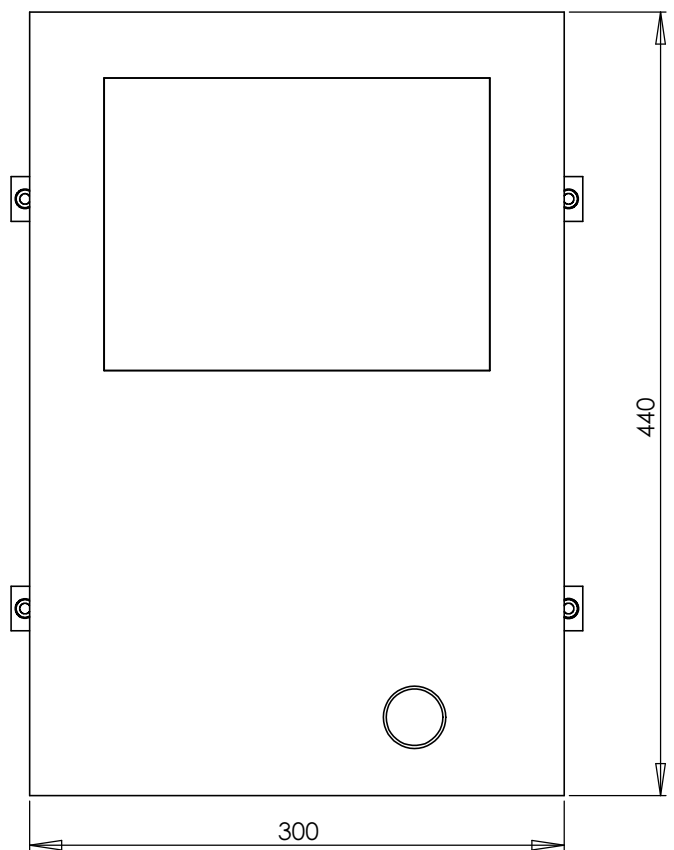
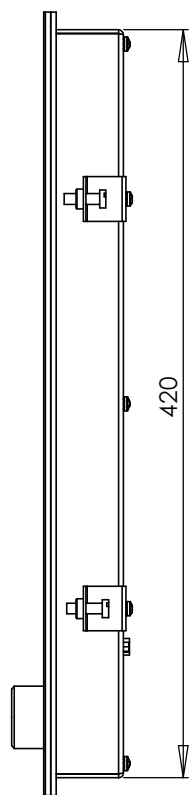
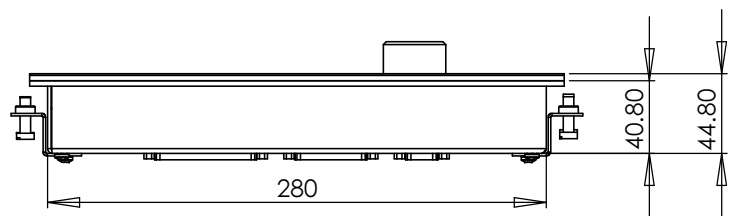

All Dimensions In mm.

UNLESS OTHERWISE SPECIFIED: DIMENSIONS ARE IN MILLIMETERS SURFACE FINISH: TOLERANCES: LINEAR: ANGULAR:				FINISH:	DEBUR AND BREAK SHARP EDGES	DO NOT SCALE DRAWING	REVISION 1.0
DRAWN: K J Mawdsley				SIGNATURE	DATE	TRM +44 (0) 1704 563777	86 Moss Road Southport PR8 4JQ
CHK'D						TITLE: complete drawing	
APP'VD						DWG NO. MET-xxx	A3
MFG							
Q.A							
					MATERIAL:		
					WEIGHT:	SCALE:1:3	SHEET 1 OF 1

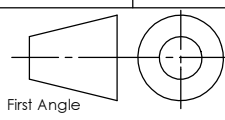

IF IN DOUBT ASK!

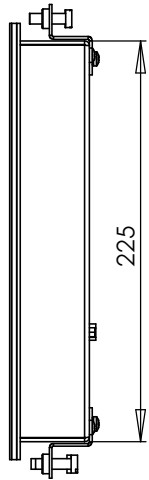
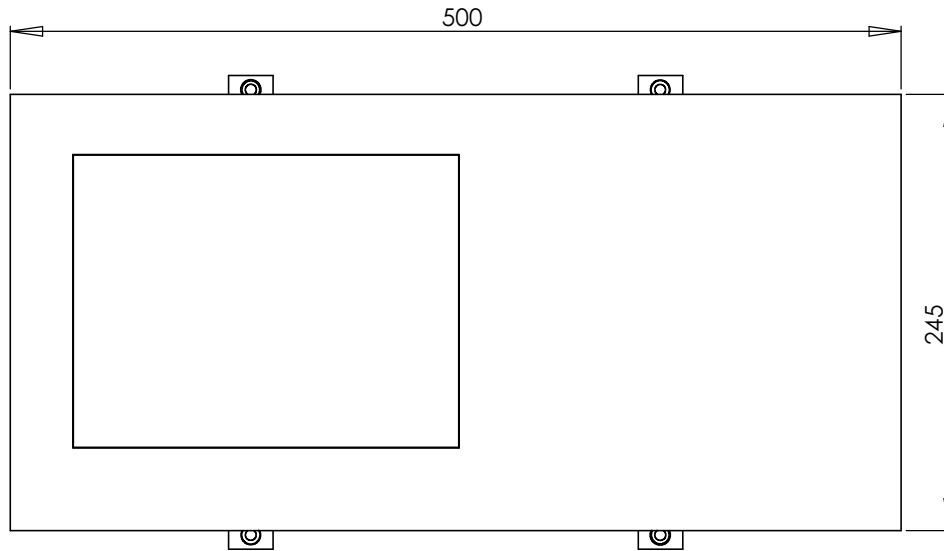
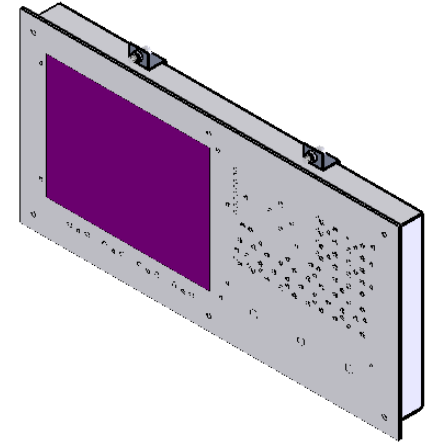
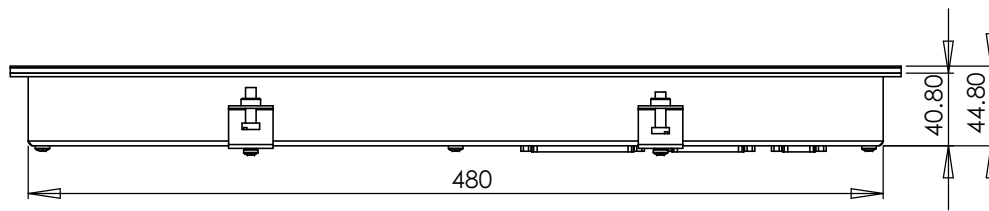

IF IN DOUBT ASK!

All Dimensions In mm.

UNLESS OTHERWISE SPECIFIED: DIMENSIONS ARE IN MILLIMETERS SURFACE FINISH: TOLERANCES: LINEAR: ANGULAR:				FINISH:	DEBUR AND BREAK SHARP EDGES	DO NOT SCALE DRAWING	REVISION 1.0
DRAWN: K J Mawdsley				SIGNATURE	DATE	TRM +44 (0) 1704 563777	86 Moss Road Southport PR8 4JQ
CHK'D						TITLE: SMC 10.xL ALL	
APP'VD						DWG NO. MET-xxx	A3
MFG					MATERIAL:	SCALE: 1:3	
Q.A					WEIGHT:	SHEET 1 OF 1	

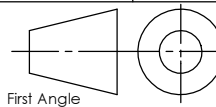

First Angle

IF IN DOUBT ASK!

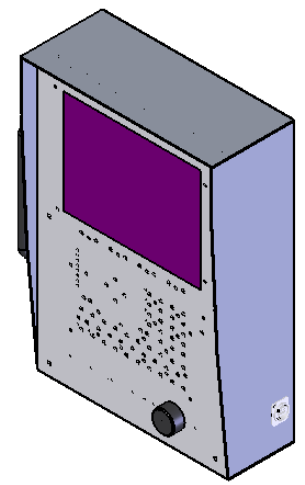
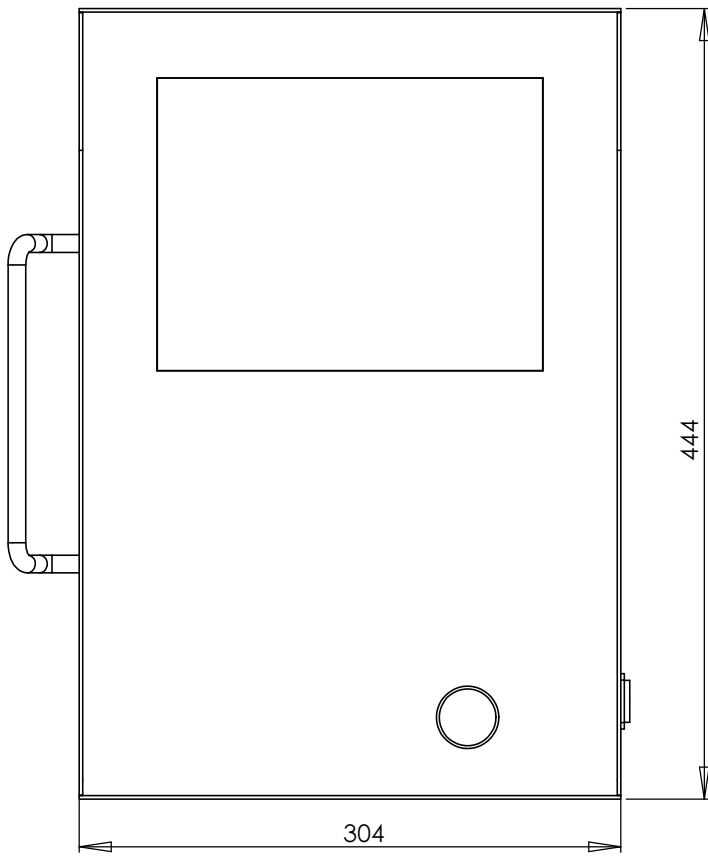
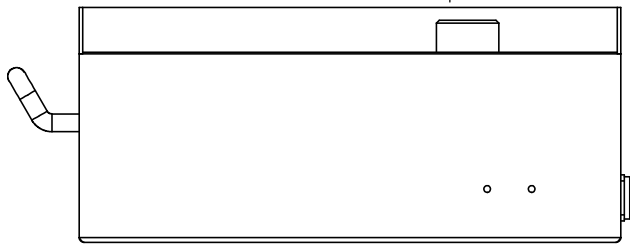
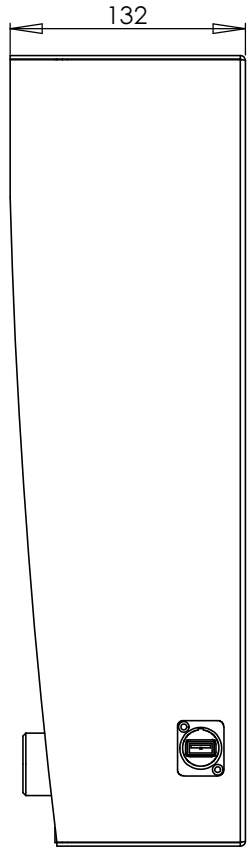

All Dimensions In mm.

UNLESS OTHERWISE SPECIFIED: DIMENSIONS ARE IN MILLIMETERS SURFACE FINISH: TOLERANCES: LINEAR: ANGULAR:				FINISH:		DEBUR AND BREAK SHARP EDGES		DO NOT SCALE DRAWING		REVISION 1.0	
DRAWN K J Mawdsley				SIGNATURE		DATE		TRM +44 (0) 1704 563777		86 Moss Road Southport PR8 4JQ	
CHK'D								<p>First Angle</p>		<p>TITLE:</p> <h1>10.4" Boom POD Mounting</h1>	
APP'VD											
MFG											
Q.A											
						MATERIAL:		DWG NO. MET-xxx		A3	
						WEIGHT:		SCALE:1:3		SHEET 1 OF 1	

IF IN DOUBT ASK!

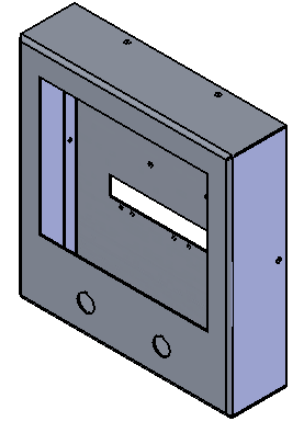
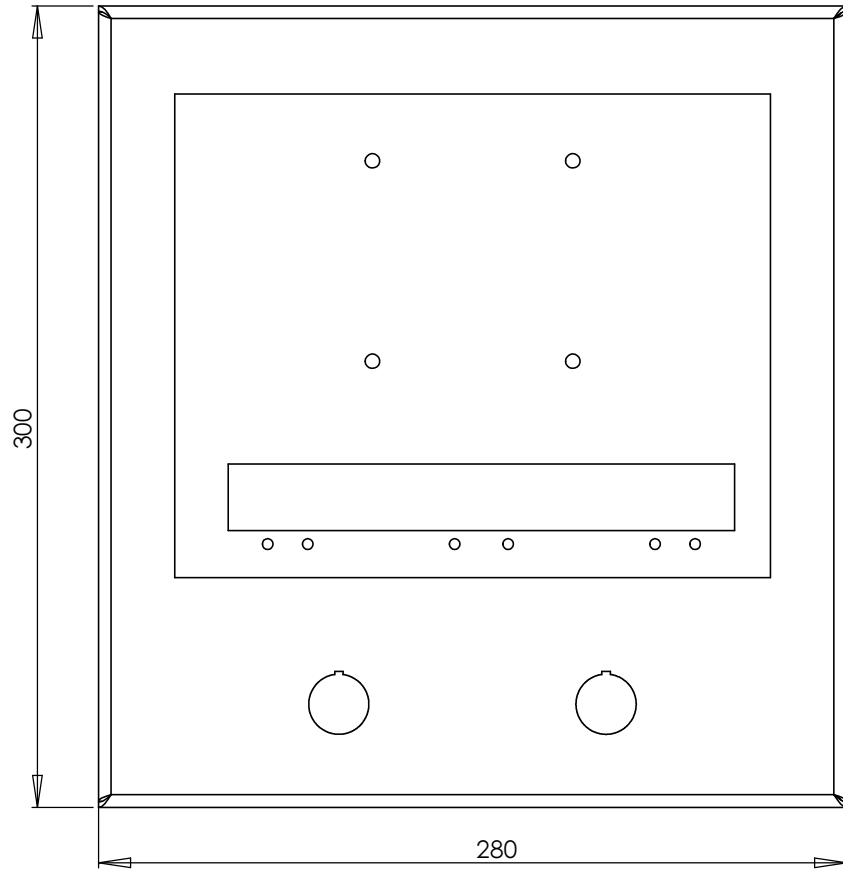
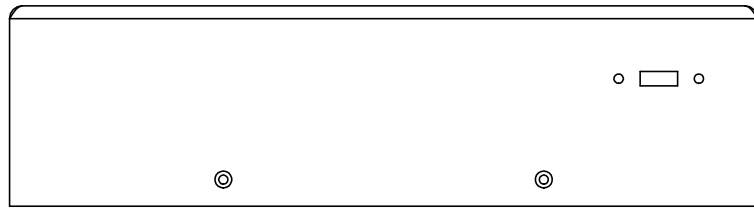
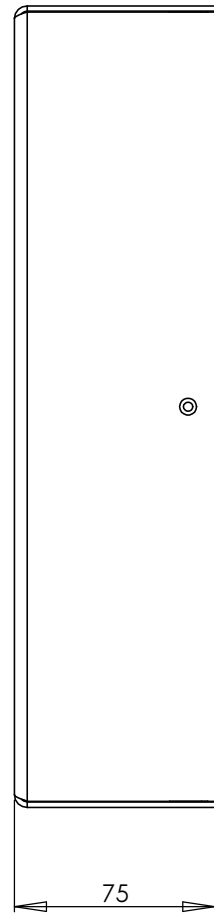

All Dimensions In mm.

UNLESS OTHERWISE SPECIFIED: DIMENSIONS ARE IN MILLIMETERS SURFACE FINISH: TOLERANCES: LINEAR: ANGULAR:				FINISH:	DEBUR AND BREAK SHARP EDGES
NAME	SIGNATURE	DATE	<p>First Angle</p>		
DRAWN	K J Mawdsley				
CHK'D					
APP'VD					
MFG					
Q.A.			MATERIAL:	DWG NO.	A3
			WEIGHT:	SCALE:1:2	SHEET 1 OF 1

DO NOT SCALE DRAWING	REVISION 1.0
TRM +44 (0) 1704 563777	86 Moss Road Southport PR8 4JQ
TITLE: <b>POD V2 Box Assembly</b>	
DWG NO. MET-xxx	A3
SCALE:1:2	SHEET 1 OF 1